

Powerful Mainstream Solution For Modern Businesses

IAP1200

2 x 2 AC1200 Dual-Band In-Wall PoE Access Point



KEY FEATURES

- **802.11ac High Speed Dual-Band:** IEEE 802.11ac concurrent dual-band with 1200Mbps wireless speed.
- **Easy Installation:** In-wall design with easy installation kit.
- **Compact Housing:** Ultra slim design.
- **Designed for High Density BYOE Usage:** Ideal for crowded environments and BYOE (Bring Your Own Everything) workplace Wi-Fi connection.
- **Multiple SSIDs for Security Management:** Supports up to 32 SSIDs (16 x 2.4GHz & 16 x 5GHz) ideal for multiple departments, user groups, customers or guests.
- **Wide Coverage & High Sensitivity:** Adjustable RF output power and high receiver sensitivity for wide coverage across large spaces.
- **Seamless Mobility:** 1.5 x greater coverage than typical APs for blanket coverage to ensure seamless connectivity for Wi-Fi devices across enterprise environments.
- **Power over Ethernet:** Supports IEEE 802.3af PoE.
- **Built-In RADIUS Server:** With management for up to 256 user accounts.
- **Business Environments:** Mainstream choice for SMBs. Suitable for a wide range of commercial applications such as offices, hotels, MDUs (Multi-Dwelling Units), airports, meeting rooms, schools, campuses etc.
- **Central Management:** Edimax Pro Network Management Suite (NMS) and SKYMANAGE PC Network Management Software for easy and intuitive web-based central management. AP built-in with NMS supports AP array architecture.

The IAP1200 is a powerful wireless solution designed to meet the needs of modern mainstream businesses. With the latest IEEE 802.11ac technology for wireless speeds up to 1200Mbps, the stylish in-wall design is specifically for existing building structures so you can easily change an existing in-wall wired Ethernet jack to a wireless access point. Ideal areas of deployment include offices, hotels, MDUs (Multi-Dwelling Units), airports, meeting rooms, schools, campuses etc.

For hotels which demand security, flexibility and speed, the IAP1200 provides guests with a convenient wireless LAN service. With standard US or EU type Ethernet wall jacks already installed, there's no need for extra time and cost to deploy a wireless network – you can reduce re-wiring costs while blending the AP with the interior décor. And the high-density capacity is ideal for BYOE workplaces or other environments with a high volume of users and wireless devices. Multiple SSIDs can be configured for different departments or user groups and a built-in RADIUS server provides additional verification. Additionally featuring Power over Ethernet support (PoE) and an intuitive web-based management interface – which provides flexibility for deployment and extensive management options for company MIS departments and network administrators.

When performance and security are critical for your business, you need products that are engineered for your industry. The Edimax Pro series is designed to help your business and provide the connectivity that you rely on every day, with safety and effectiveness guaranteed.

Central Management & PoE (Power over Ethernet) Gigabit

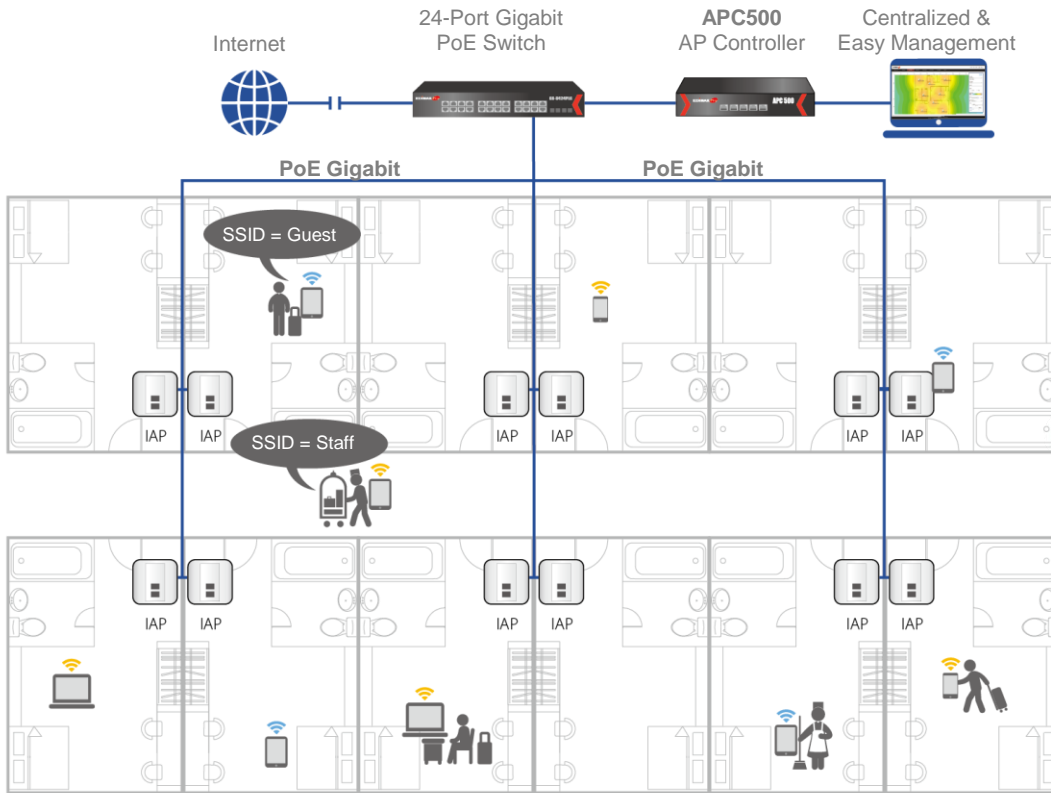

In-Wall Dual-Band



Hotel Guest Room

- IAP In-Wall AP Easy Deployment
- In-Room Dual-Band
- AC1200 High Speed
- PoE Gigabit
- Easy Centralized Management

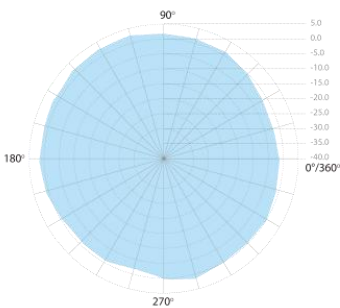

2.4GHz
2D Radiation Pattern @ Vertical

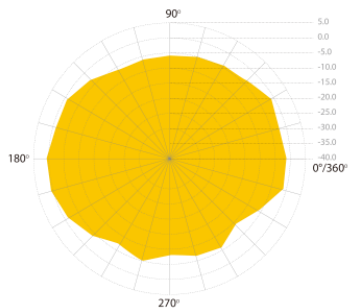

5GHz
2D Radiation Pattern @ Vertical

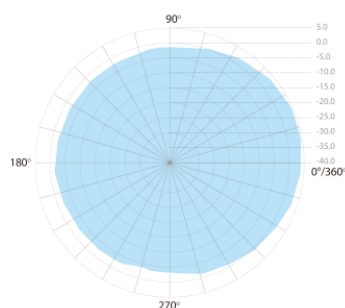

2.4GHz
2D Radiation Pattern @ Horizontal

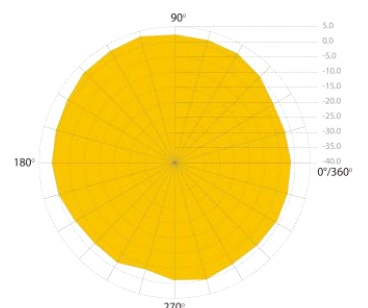

5GHz
2D Radiation Pattern @ Horizontal

Central Network Management: NMS & SKYPMANAGE PC

Work with Edimax Pro NMS (Network Management Suite) * and SKYMANAGE PC* web-based wireless network management software. Company MIS administrators can plan and manage Edimax Pro access points' powerful functionality according to their office space using an easy, remote web-based interface which includes a dashboard, map view, traffic statistics and wireless client list for network-wide remote administration. RADIUS settings, WLAN group settings, access control, guest network settings and firmware upgrades can all be managed centrally from a single location to reduce network downtime, aid troubleshooting and optimize network performance. Graphical zone plans with Google Maps integration and setup wizards are also available for expanding and managing large networks with multiple access points, with custom floor plans, visual overviews and easy drag-and-drop icons for quick access to key performance and monitoring information.

*NMS is built-in with Edimax Pro CAP, WAP series & OAP1750 access point. For SKYMANAGE PC, please contact Edimax authorized distributors or SIs to download the software.

Ideal areas of deployment include offices, hotels, MDUs (Multi-Dwelling Units), airports, meeting rooms, schools and campuses.



Easy Installation

3-Step Easy Installation

1

Connect an RJ45 LAN cable to the IAP1200's rear PoE LAN port.

2

Screw the IAP1200 securely on to the wall.

3

Attach the wall plate to the IAP1200.

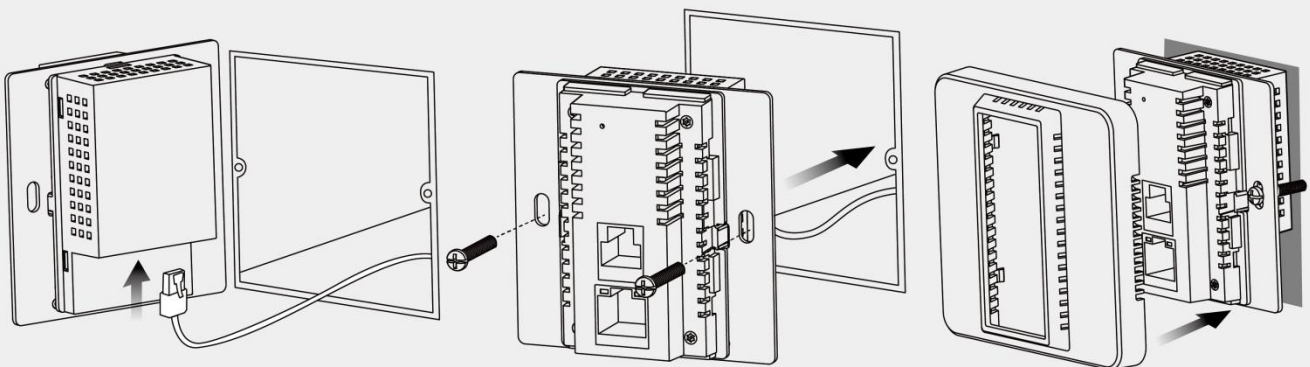

2 x 2 AC Dual-Band In-Wall PoE Access Point

SPECIFICATIONS

Hardware	
LAN Interface	Giga x 2, RJ11 x 2
PoE	802.3af (Supports 802.3at)
Antenna	Type: 2 x Built-In PIFA Gain: 2.14dBi (2.4GHz), 3.8dBi (5GHz) Max.
Power	802.3af (Support 802.3at)
Dimensions (L x W x H)	Faceplate Set : 70 x 115 x10mm (US-Type) Faceplate Set : 86 x 86 x10mm (EU-Type) Stand/Mounting Bracket : 48.5 x 74 x 38mm
Weight	125g
Power Consumption (Full Loading)	8W
Mounting	In-wall
Reset	Y
LED Indicator	1. Power LED 2. Diag LED
Environmental Conditions	Operating Temperature: 0°C (32°F) to 40°C (104°F) Storage Temperature: -20°C (-4°F) to 60°C (140°F)
	Operating Humidity: 90% or Less Storage Humidity: 90% or Less
Power Saving	802.3az
Internal Buzzer	Y
Housing	Flammability Rating Plastic
Wireless	
Standard	802.11 a/b/g/n/ac Concurrent Dual-Band
No. of Radios	2
Receiver Sensitivity	≤ -91dBm
Certification	CE/FCC
Number of SSIDs	16 (2.4GHz) + 16 (5GHz)
Performance	
Maximum Data Speed	300 + 867Mbps
Concurrent Clients	Up to 50 Per Radio
Security	
Encryption	WEP / WPA / WPA2
Wireless L2 Isolation	Y
Station Isolation	Y
IEEE 802.1x Authenticator	Y
EAP Authentication	PEAP
Hidden SSID	Y
MAC Address Filter	Y
Wireless STA	Y
Rogue AP Detection (w/NMS)	Y
Software	
Wireless Mode	AP / WDS AP / WDS Bridge
802.1q VLAN	Y (VID = 1-4095)
Spanning Tree	RSTP
QoS	WMM (802.11e)
	Max Associated Station No.
Pass-Through	IPv6 and VPN (PPTP, L2TP/IPsec)
DSCP (802.1p)	Y
Multicast Rate up to 54Mbps	Y

RF Specifications	
Frequency Band	•Radio I : 802.11b/g/n 2.412~2.484(GHz) •Radio II : 802.11a/n/ac 5.18~5.24(GHz), 5.745~5.825(GHz) (The supported frequency band is restricted by local regulations.)
Operation Channels	•2.4GHz : US/Canada 1-11; 2.412~2.462GHz Europe 1-13; 2.412~2.472GHz Japan 1-14; 2.412~2.484GHz •5GHz : Country dependent for the following ranges: US/Canada: Band 1:36, 40, 44, 48; 5.180~5.240(GHz) Band 4:149, 153, 157, 161, 165; 5.745~5.825(GHz) Europe: Band 1:36, 40, 44, 48; 5.745~5.825(GHz)
Transmit Power	802.11b 10dBm@1Mbps 10dBm@2Mbps 10dBm@5.5Mbps 10dBm@11Mbps 802.11g 10dBm@6Mbps 10dBm@9Mbps 10dBm@12Mbps 10dBm@18Mbps 10dBm@24Mbps 10dBm@36Mbps 10dBm@48Mbps 10dBm@54Mbps 802.11n (2.4G) 10dBm@MCS0/MCS8 10dBm@MCS1/MCS9 10dBm@MCS2/MCS10 10dBm@MCS3/MCS11 10dBm@MCS4/MCS12 10dBm@MCS5/MCS13 10dBm@MCS6/MCS14 10dBm@MCS7/MCS15
	802.11a 10dBm@6Mbps 10dBm@9Mbps 10dBm@12Mbps 10dBm@18Mbps 10dBm@24Mbps 10dBm@36Mbps 10dBm@48Mbps 10dBm@54Mbps 802.11n(5G) 10dBm@MCS0/MCS8 10dBm@MCS1/MCS9 10dBm@MCS2/MCS10 10dBm@MCS3/MCS11 10dBm@MCS4/MCS12 10dBm@MCS5/MCS13 10dBm@MCS6/MCS14 10dBm@MCS7/MCS15 802.11ac 10dBm@MCS0 10dBm@MCS1 10dBm@MCS2 10dBm@MCS3 10dBm@MCS4 10dBm@MCS5 10dBm@MCS6 10dBm@MCS7 10dBm@MCS8 10dBm@MCS9
Receiver Sensitivity	802.11b ≤-91dBm@1Mbps ≤-87dBm@11Mbps 802.11g ≤-90dBm@6Mbps ≤-71dBm@54Mbps 802.11n (2.4G) ≤-87dBm@MCS0 ≤-68dBm@MCS7 ≤-85dBm@MCS8 ≤-65dBm@MCS15 802.11a ≤-90dBm@6Mbp ≤-71dBm@54Mbps 802.11n(5G) ≤-86dBm@MCS0 ≤-69dBm@MCS7 ≤-84dBm@MCS8 ≤-65dBm@MCS15 802.11ac ≤-82dBm@MCS0 ≤-63dBm@MCS9 ≤-83dBm@MCS10 ≤-55dBm@MCS19
Management	
Deployment	Standalone (AP Mode)
	Managed AP mode: Managed by AP Controller (APC500), Edimax Pro Master AP with NMS or SKYMANAGE PC Software
Configuration	HTTP/HTTPS
	SNMP v1, v2c, v3
	CLI (Telnet, SSH)
RADIUS Server	Built-In
Auto-Channel	Y
Private MIB	Y
Package Contents	
Access Point	AC1200 In-Wall PoE Access Point
Mounting Bracket	In-Wall-Mount Bracket Kit
Quick Installation Guide	Printed English Quick Installation Guide

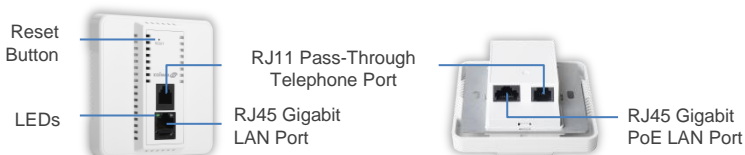

Maximum performance, actual data rates, and coverage will vary depending on network conditions and environmental factors. Product specifications and design are subject to change without notice. Copyright © 2017 Edimax Technology Co. Ltd. All rights reserved.



www.edimax.com